

## Bath Floor Plans

### 1811 Bar

Reception

### Royal Crescent

Theatre  
Boardroom  
Cabaret  
Dinner

### The Roof Garden

Reception

### Paddock Pavilion

Dinner  
Theatre  
Reception

### Owners and Trainers

Reception  
Cabaret

### The Mornington Suite

Theatre  
Boardroom  
Cabaret  
Dinner

### Executive Boxes

Boxes 1-4  
Boxes 5-7  
Boxes 8-9



Product  
Launches



Conferences  
and events



Corporate  
Celebrations







Team  
Building

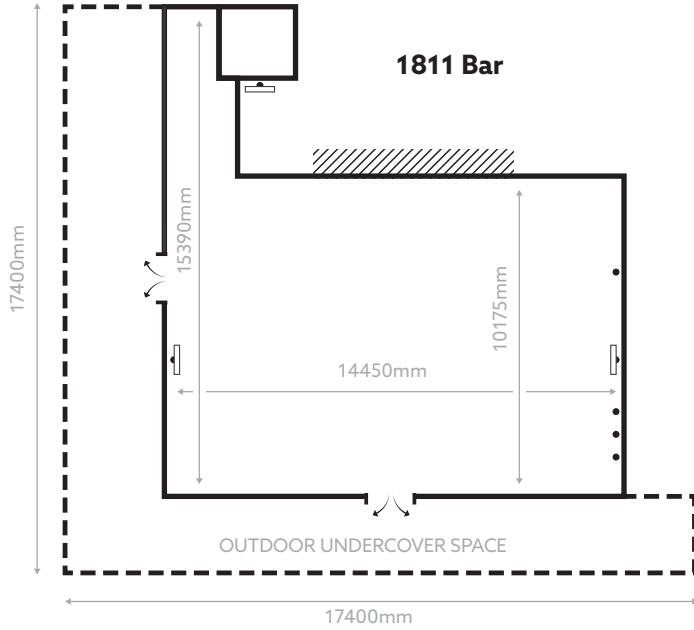

Boardroom  
Awayday



- BALCONY
- //// BAR
- ∩ ∪ DOOR
- POWER
- ⊝ ○ PILLAR
- ▭ TV

-  **Product Launches**
-  **Conferences and events**
-  **Corporate Celebrations**
-  **Team Building**
-  **Boardroom Awayday**

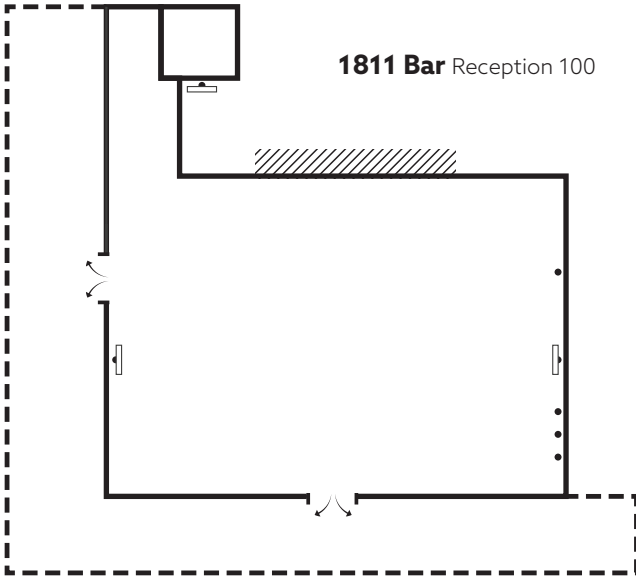

1811 Bar Reception 100



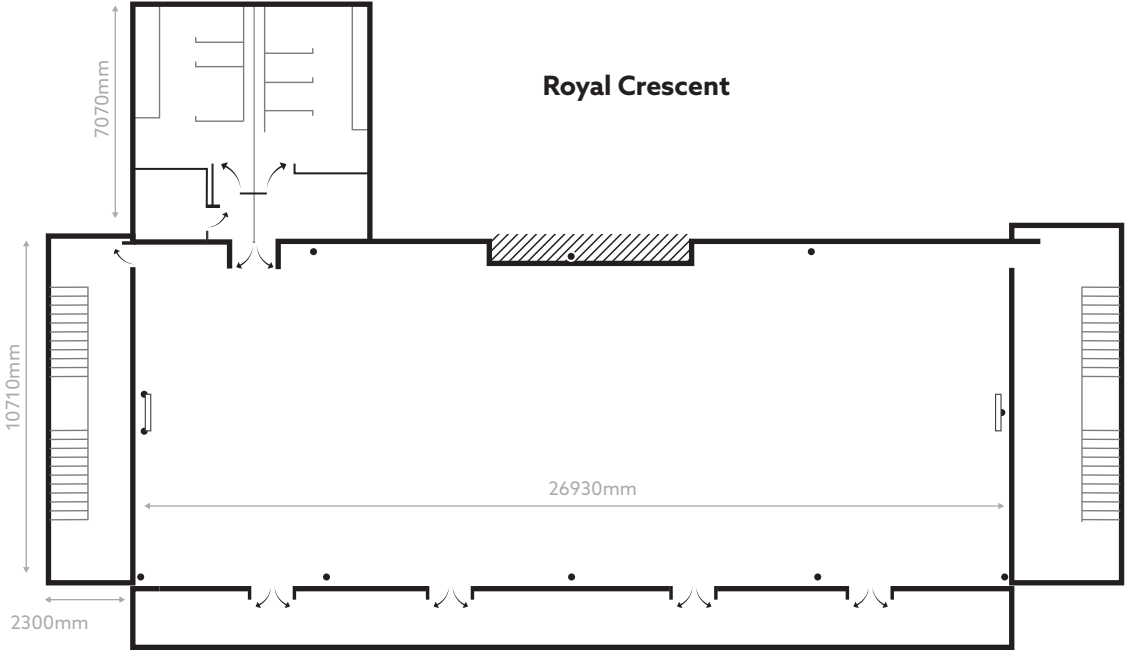

- BALCONY
- //// BAR
- ∩∪ DOOR
- POWER
- ⊕○ PILLAR
- ▭ TV

- 
- Product Launches
  - Conferences and events
  - Corporate Celebrations
  - Team Building
  - Boardroom Awayday

# Royal Crescent



- BALCONY
- //// BAR
- ∩ ∪ DOOR
- POWER
- D-O PILLAR
- TV

-  **Product Launches**
-  **Conferences and events**
-  **Corporate Celebrations**
-  **Team Building**
-  **Boardroom Awayday**

**Royal Crescent Theatre 300**

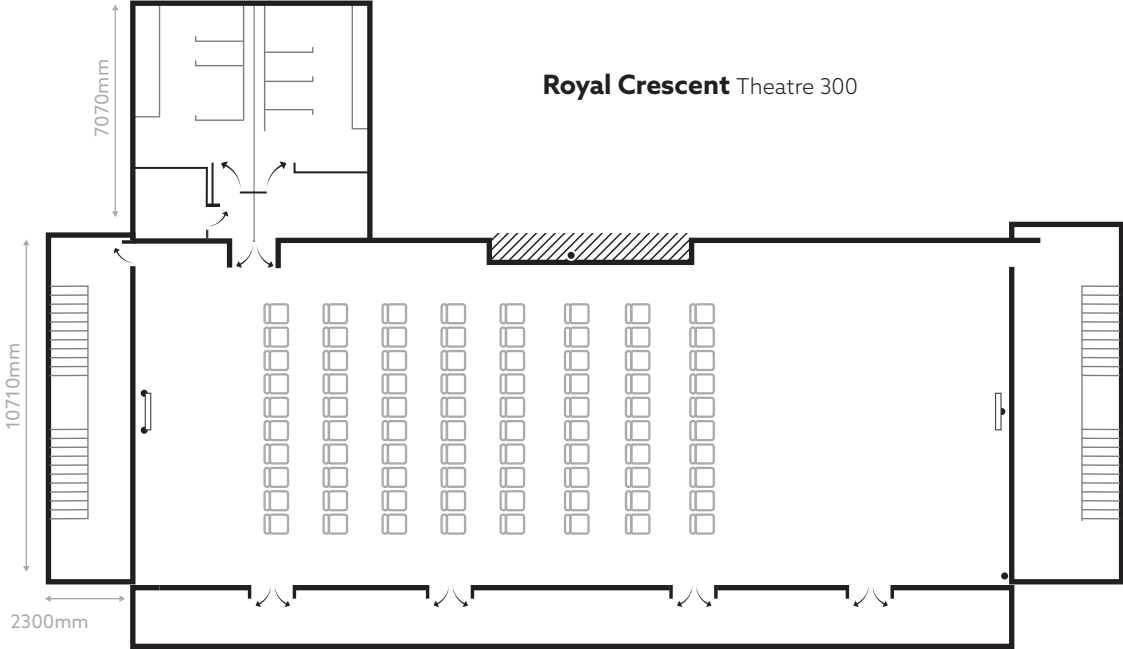



- BALCONY
- //// BAR
- ∩ ∪ DOOR
- POWER
- PILLAR
- TV

- Product Launches**
- Conferences and events**
- Corporate Celebrations**
- Team Building**
- Boardroom Awayday**

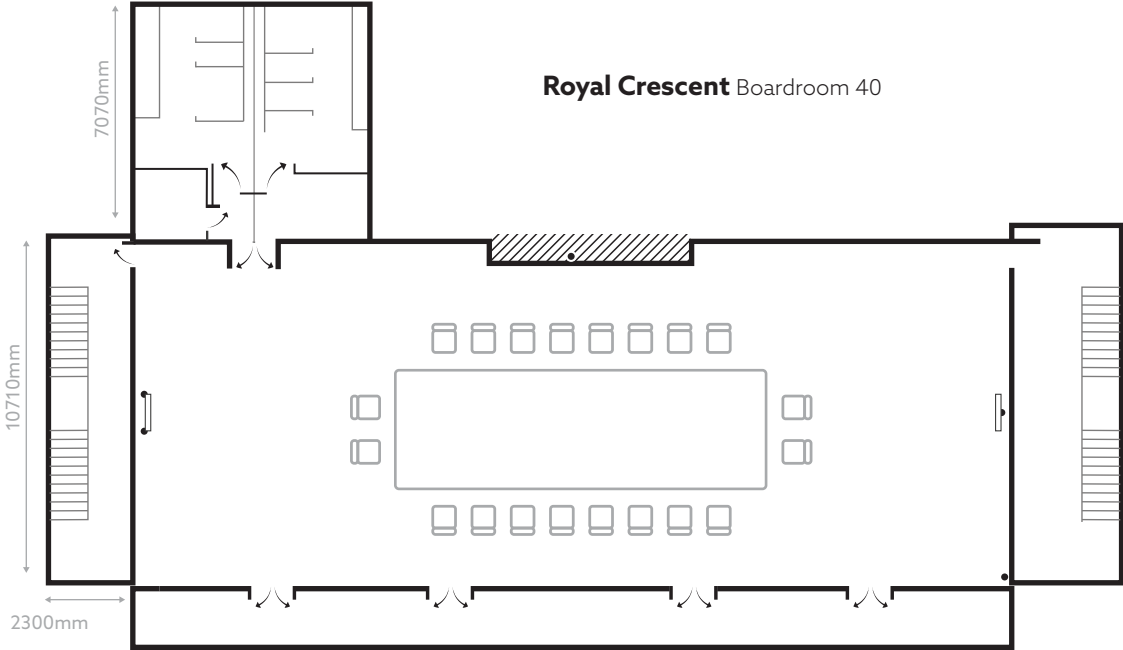
### Royal Crescent Boardroom 40



- BALCONY
- //// BAR
- ∩ ∪ DOOR
- POWER
- ○ PILLAR
- TV

-  **Product Launches**
-  **Conferences and events**
-  **Corporate Celebrations**
-  **Team Building**
-  **Boardroom Awayday**

**Royal Crescent Cabaret 144**

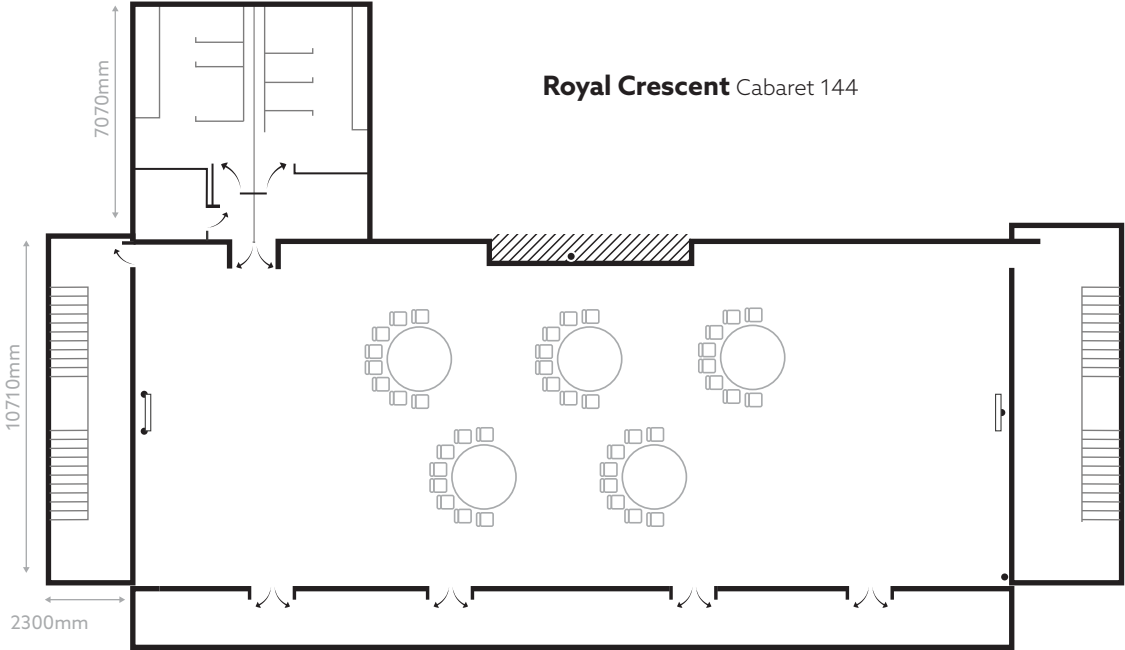



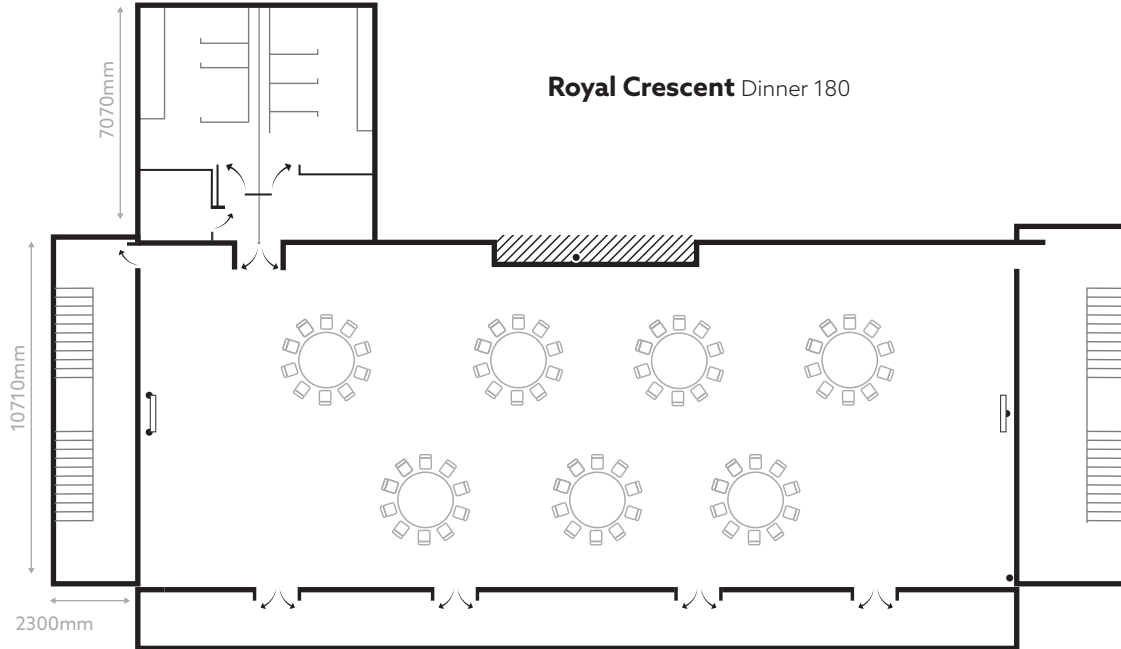

- BALCONY
- //// BAR
- ∩ ∪ DOOR
- POWER
- ○ PILLAR
- TV

-  **Product Launches**
-  **Conferences and events**
-  **Corporate Celebrations**
-  **Team Building**
-  **Boardroom Awayday**

## Royal Crescent Dinner 180





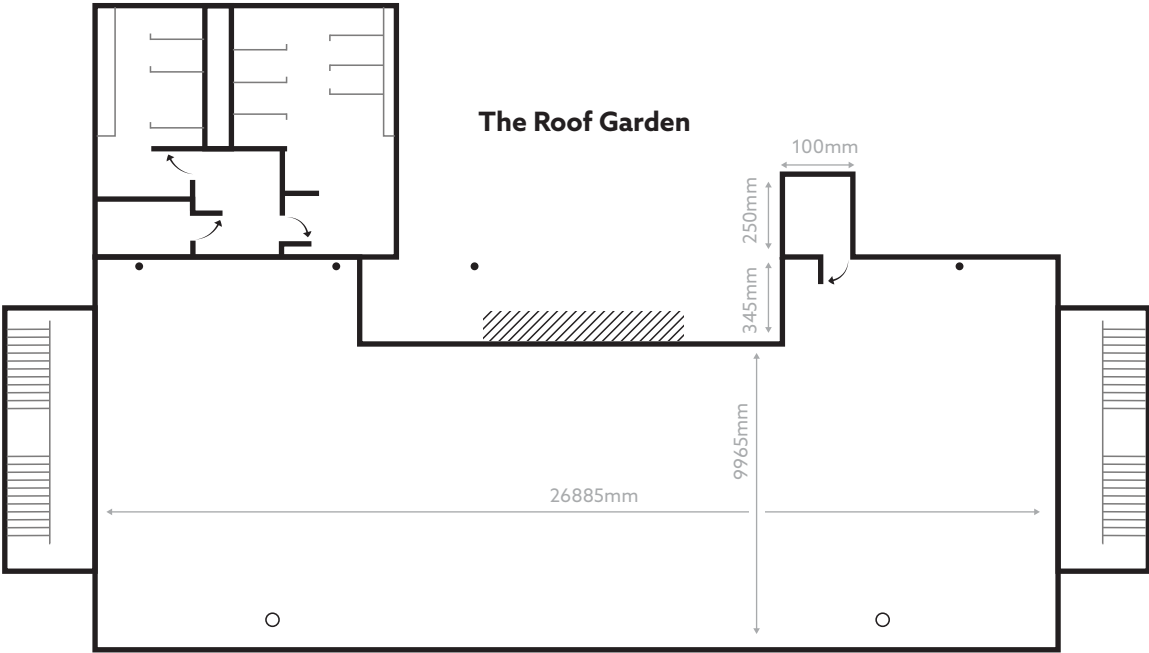

- BALCONY
- //// BAR
- ∩ ∪ DOOR
- POWER
- D-O PILLAR
- TV

-  **Product Launches**
-  **Conferences and events**
-  **Corporate Celebrations**
-  **Team Building**
-  **Boardroom Awayday**





- BALCONY
- /// BAR
- ∩∪∩ DOOR
- POWER
- D-O PILLAR
- TV

-  **Product Launches**
-  **Conferences and events**
-  **Corporate Celebrations**
-  **Team Building**
-  **Boardroom Awayday**



### The Roof Garden Reception 200

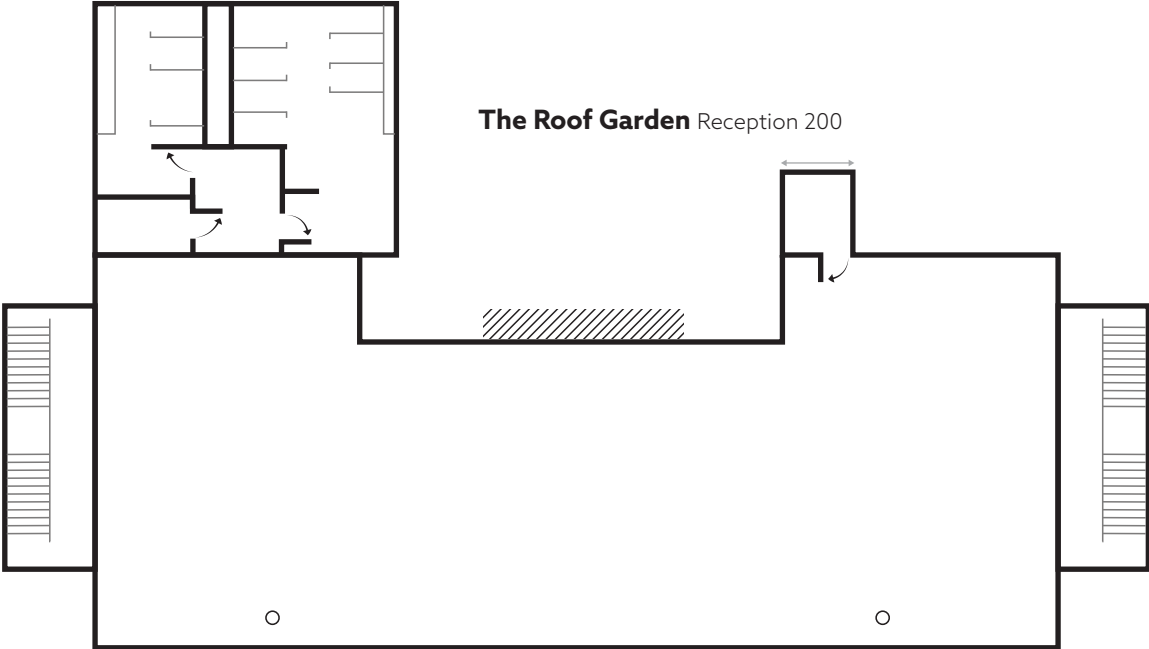

- BALCONY
- //// BAR
- ∩∪ DOOR
- POWER
- D-O PILLAR
- TV

- Product Launches
- Conferences and events
- Corporate Celebrations
- Team Building
- Boardroom Awayday

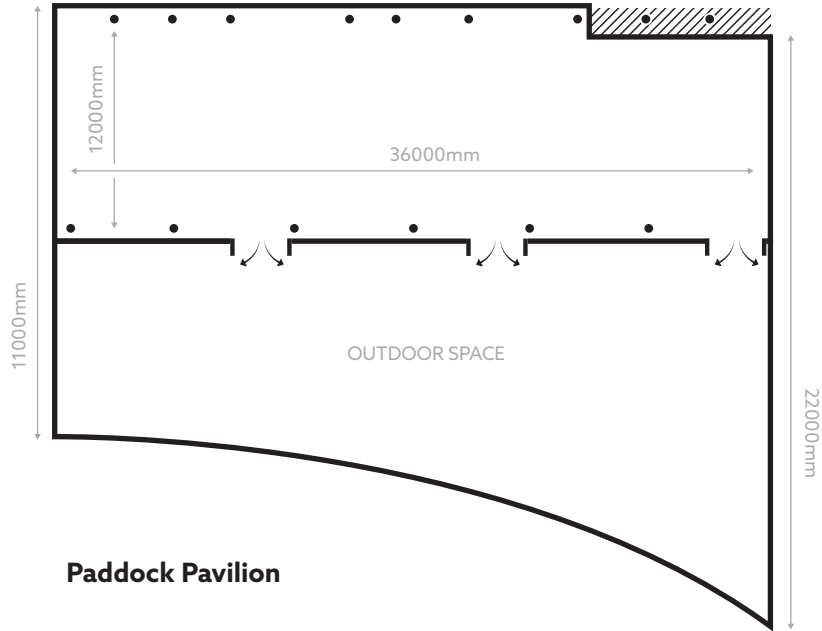

- BALCONY
- /// BAR
- ∩ DOOR
- POWER
- ⊙ PILLAR
- ▭ TV

- Product Launches
- Conferences and events
- Corporate Celebrations
- Team Building
- Boardroom Awayday

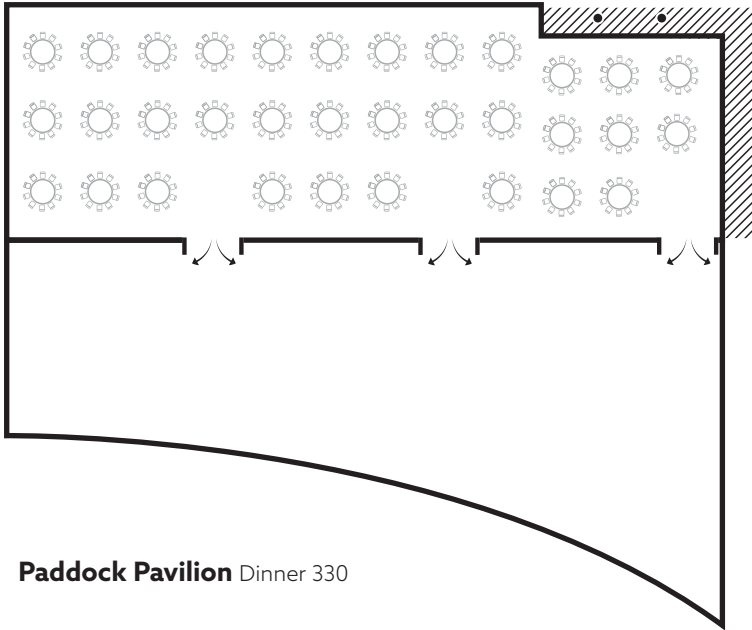

**Paddock Pavilion** Dinner 330

- BALCONY
- /// BAR
- ∩∩ DOOR
- POWER
- PILLAR
- TV

- Product Launches
- Conferences and events
- Corporate Celebrations
- Team Building
- Boardroom Awayday

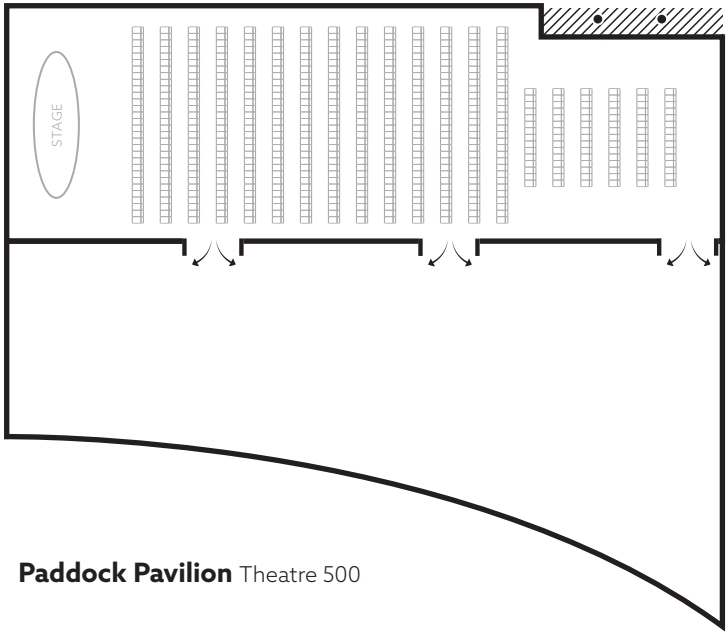

**Paddock Pavilion** Theatre 500

- BALCONY
- //// BAR
- ⌞ DOOR
- POWER
- ⊝ PILLAR
- ▭ TV

- Product Launches
- Conferences and events
- Corporate Celebrations
- Team Building
- Boardroom Awayday

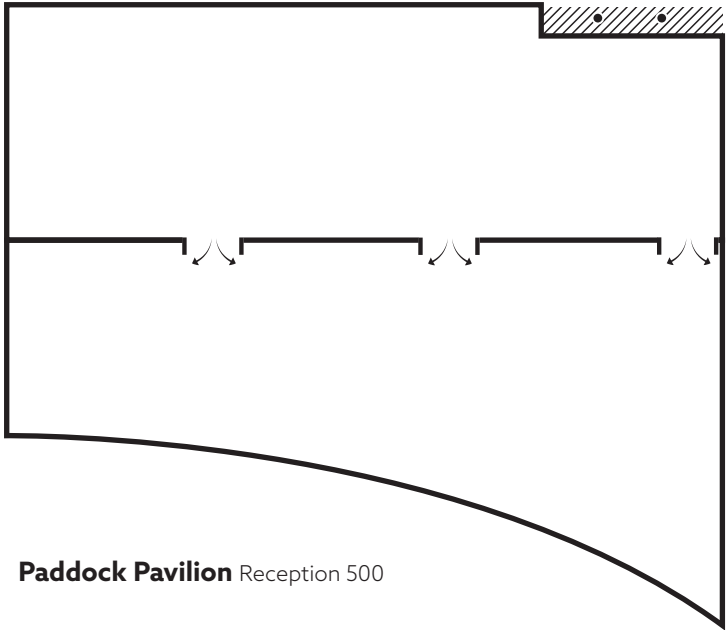

**Paddock Pavilion** Reception 500

- BALCONY
- //// BAR
- ∩∩ DOOR
- POWER
- D-O PILLAR
- TV

- Product Launches
- Conferences and events
- Corporate Celebrations
- Team Building
- Boardroom Awayday



- BALCONY
- //// BAR
- ∩∪ DOOR
- POWER
- ⊖○ PILLAR
- ▭ TV

- Product Launches
- Conferences and events
- Corporate Celebrations
- Team Building
- Boardroom Awayday

**Owners and Trainers**

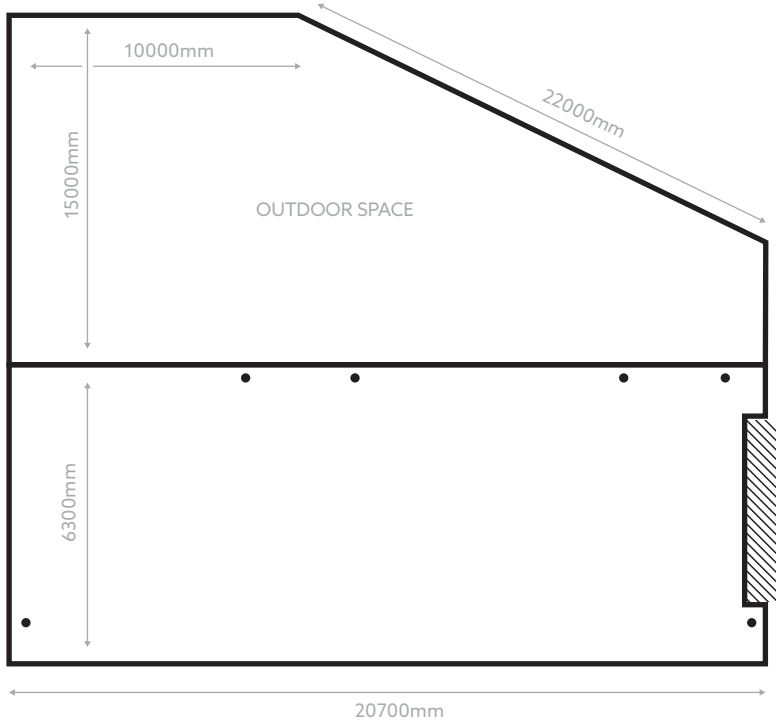

**Owners and  
Trainers**  
Reception 120

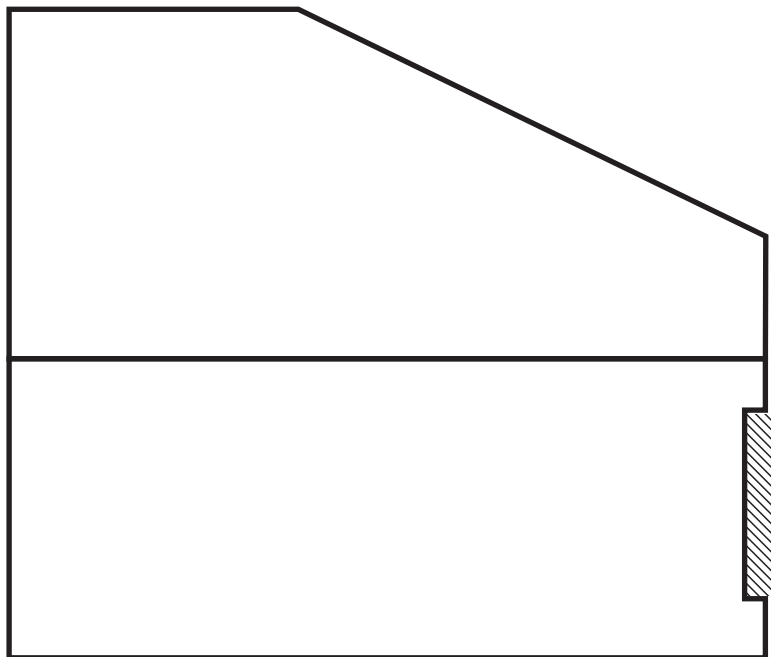

- BALCONY
- //// BAR
- ∩ ∪ DOOR
- POWER
- D-O PILLAR
- TV

- 
- Product Launches**
  - Conferences and events**
  - Corporate Celebrations**
  - Team Building**
  - Boardroom Awayday**





- BALCONY
- //// BAR
- ∩ ∪ DOOR
- POWER
- D-O PILLAR
- TV

 **Product Launches**

 **Conferences and events**

 **Corporate Celebrations**

 **Team Building**

 **Boardroom Awayday**



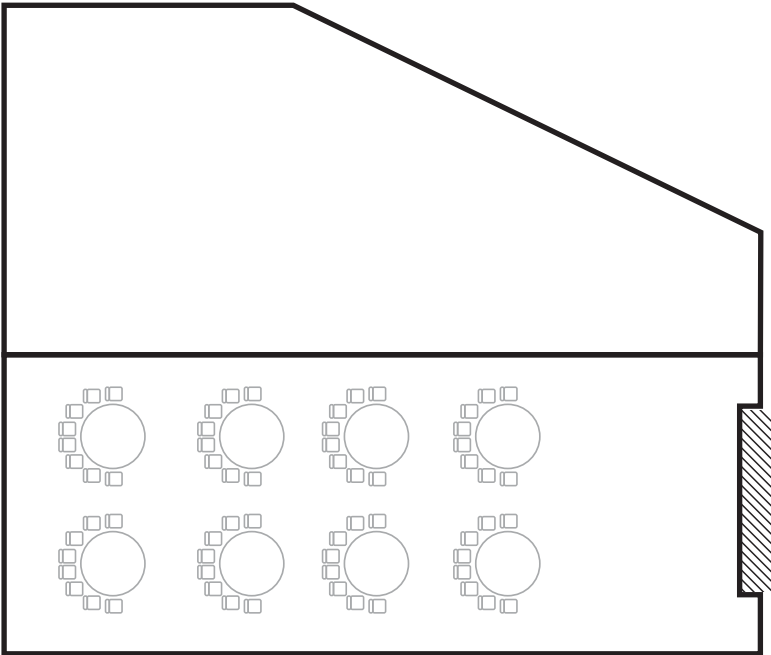

**Owners and Trainers**  
Cabaret 60

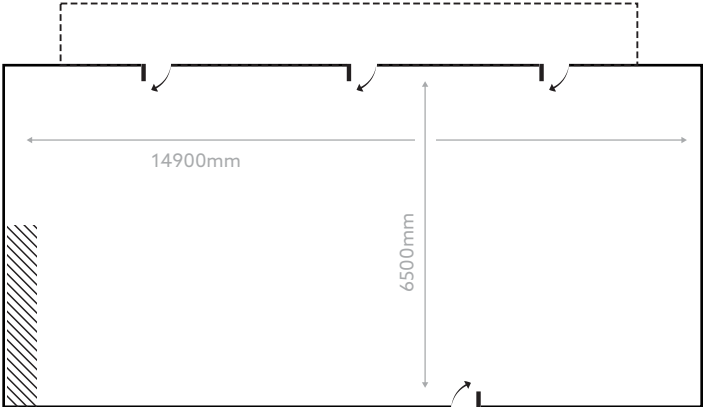

### Mornington Suite



- BALCONY
- //// BAR
- ∩∪ DOOR
- POWER
- ⊝ PILLAR
- ▭ TV

-  Product Launches
-  Conferences and events
-  Corporate Celebrations
-  Team Building
-  Boardroom Awayday



### Mornington Suite Theatre 80

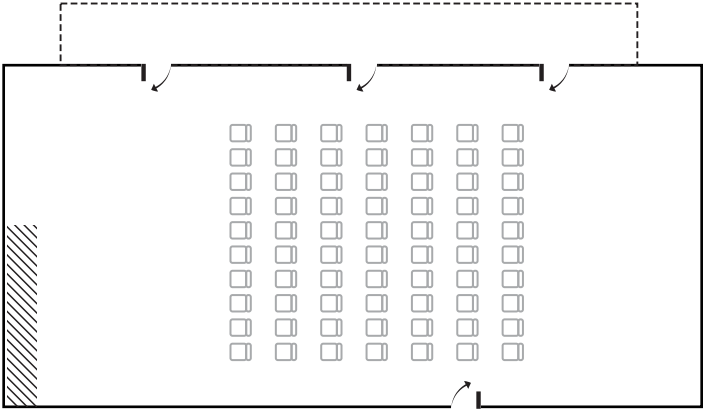

- BALCONY
- //// BAR
- ∩∪ DOOR
- POWER
- D-O PILLAR
- TV

 Product Launches

 Conferences and events

 Corporate Celebrations

 Team Building

 Boardroom Awayday



### Mornington Suite Boardroom 21

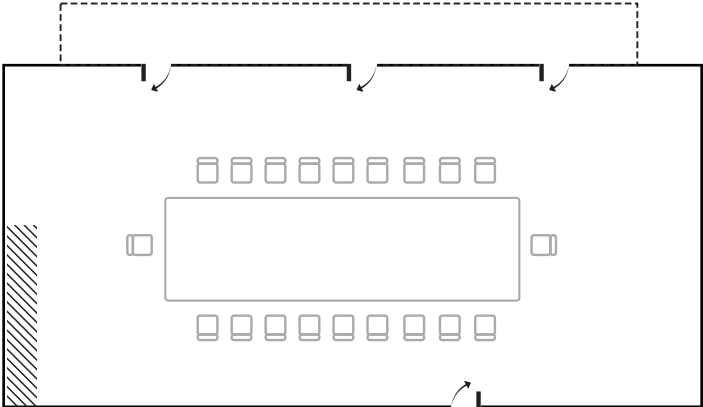

- BALCONY
- //// BAR
- ∩ ∪ DOOR
- POWER
- D-O PILLAR
- TV

- Product Launches
- Conferences and events
- Corporate Celebrations
- Team Building
- Boardroom Awayday



### Mornington Suite Cabaret 48

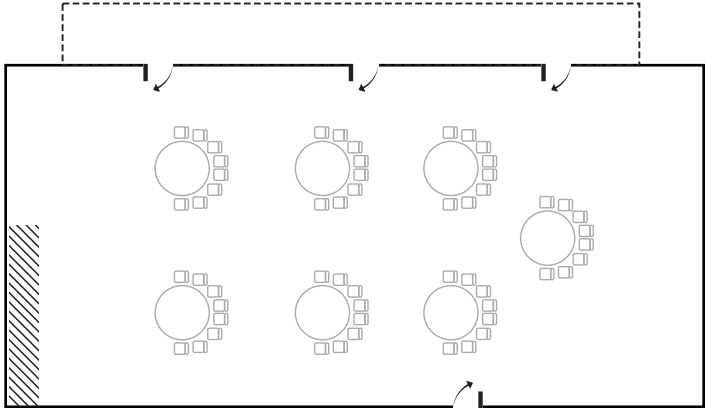

- BALCONY
- //// BAR
- ∩ ∪ DOOR
- POWER
- D-O PILLAR
- TV

- Product Launches
- Conferences and events
- Corporate Celebrations
- Team Building
- Boardroom Awayday



### Mornington Suite Dinner 70

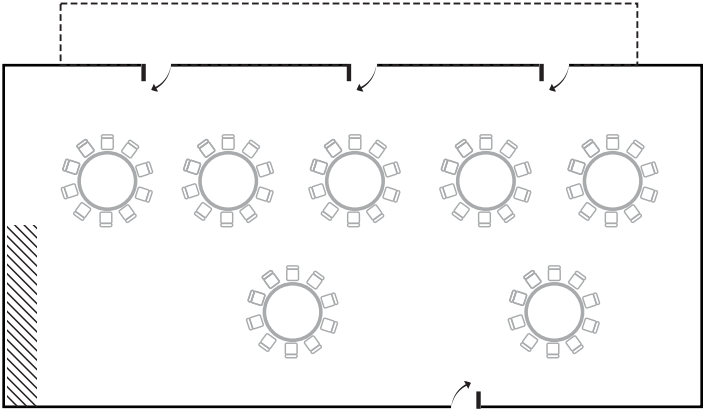



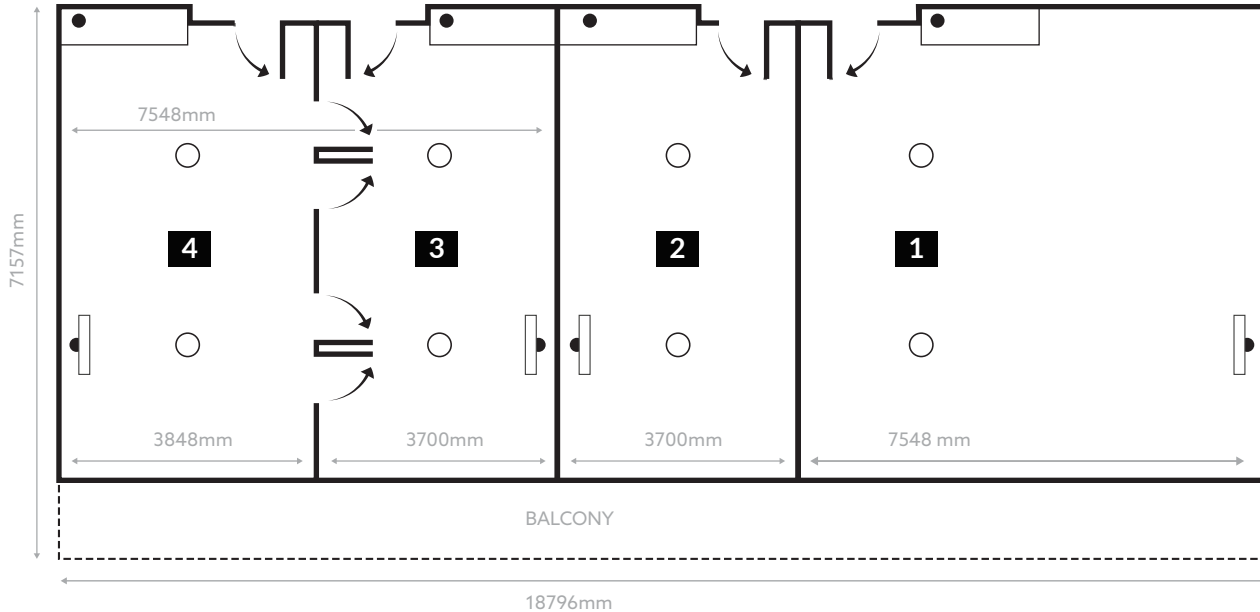

- BALCONY
- //// BAR
- ∩ ∪ DOOR
- POWER
- D-O PILLAR
- TV

- Product Launches
- Conferences and events
- Corporate Celebrations
- Team Building
- Boardroom Awayday

## Executive Boxes 1-4



- BALCONY
- //// BAR
- ⌂ DOOR
- POWER
- ⊙ PILLAR
- ▭ TV

-  **Product Launches**
-  **Conferences and events**
-  **Corporate Celebrations**
-  **Team Building**
-  **Boardroom Awayday**

### CAPACITIES

Box 1	40
Box 2	20
Box 3	20
Box 4	20



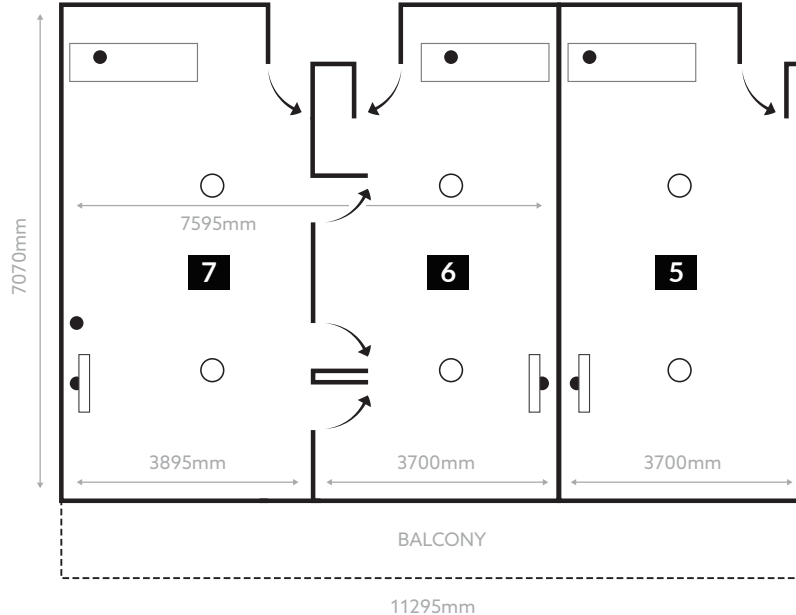

### COMBINED

Box 3 & 4	40
-----------	----

## Executive Boxes 5-7



- BALCONY
- //// BAR
- ∩ ∪ DOOR
- POWER
- PILLAR
- ▭ TV

-  **Product Launches**
-  **Conferences and events**
-  **Corporate Celebrations**
-  **Team Building**
-  **Boardroom Awayday**

### CAPACITIES

Box 5	20
Box 6	20
Box 7	20

### COMBINED





Box 6 & 7	40
-----------	----



## Executive Boxes 8-9



- BALCONY
- //// BAR
- ||| DOOR
- POWER
- PILLAR
- ▭ TV

-  Product Launches
-  Conferences and events
-  Corporate Celebrations
-  Team Building
-  Boardroom Awayday

### CAPACITIES

Box 8	20
Box 9	40

### COMBINED

Box 8 & 9	60
-----------	----